

Kinco Human-machine Interface



Kinco HMI

MT4000 Series

MT5000 Series

Text Display Series

Corporate Profile



Kinco Automation is a leading supplier of industrial automation products and solutions from China with full line of automation products including industrial human machine interfaces (HMI), AC servo systems, stepper systems, PLC, VFD and field bus products. Kinco aims to help you achieve a leading position in your market.

Reliable partner of your success

- Gain the competitive edge
- Support your business
- Serve your needs

High standard of quality management

- 100% function and reliability test before delivery
- Quality control and tracking go through the full product life cycle
- Certificated process control and quality management capability

Proven performance

- Customers in over 40 countries and in diverse markets and sectors



Perpetual innovation

- 8% of annual turnover invested in R&D
- Experienced international R&D teams
- Patent applications continue to rise every year
- Market-driven R&D: we organize our R&D activities around the voice from the customers

Provide Chinese Automation Solutions for Global Customers

CONTENTS

MT4000 Series 03

System Description
Hardware Description
Technical Specification
Dimensions

MT5000 Series 13

System Description
Hardware Description
Technical Specification
Dimensions

Text Display MD200/300 Series 25

Software Description 27

System Description

As the industrial competition is getting fiercer, more and more customers demand HMI products featuring more powerful functions, more convenient operation, quicker response speed, and lower cost. As an upgraded version, the MT4000 is designed to meet customer requirements. It derives from our consistent efforts to improve HMI touch screens and represents one of the many high-performance products for industrial applications.

Supporting almost all the mainstream functions for Middle-End applications with high performance, the MT4000 adopts the 32-bit RISC CPU, capable of calling complicated shapes and satisfying the requirements of most customers. It can communicate directly with many PLCs, while no special program is required for data transfer with these PLCs. In addition, it supports such functions as online simulation, super-large storage space for user configurations, and macros compatible with the standard C language. It can perform on-site data collection, processing, monitoring, and output in a quick, effective, and secure way.

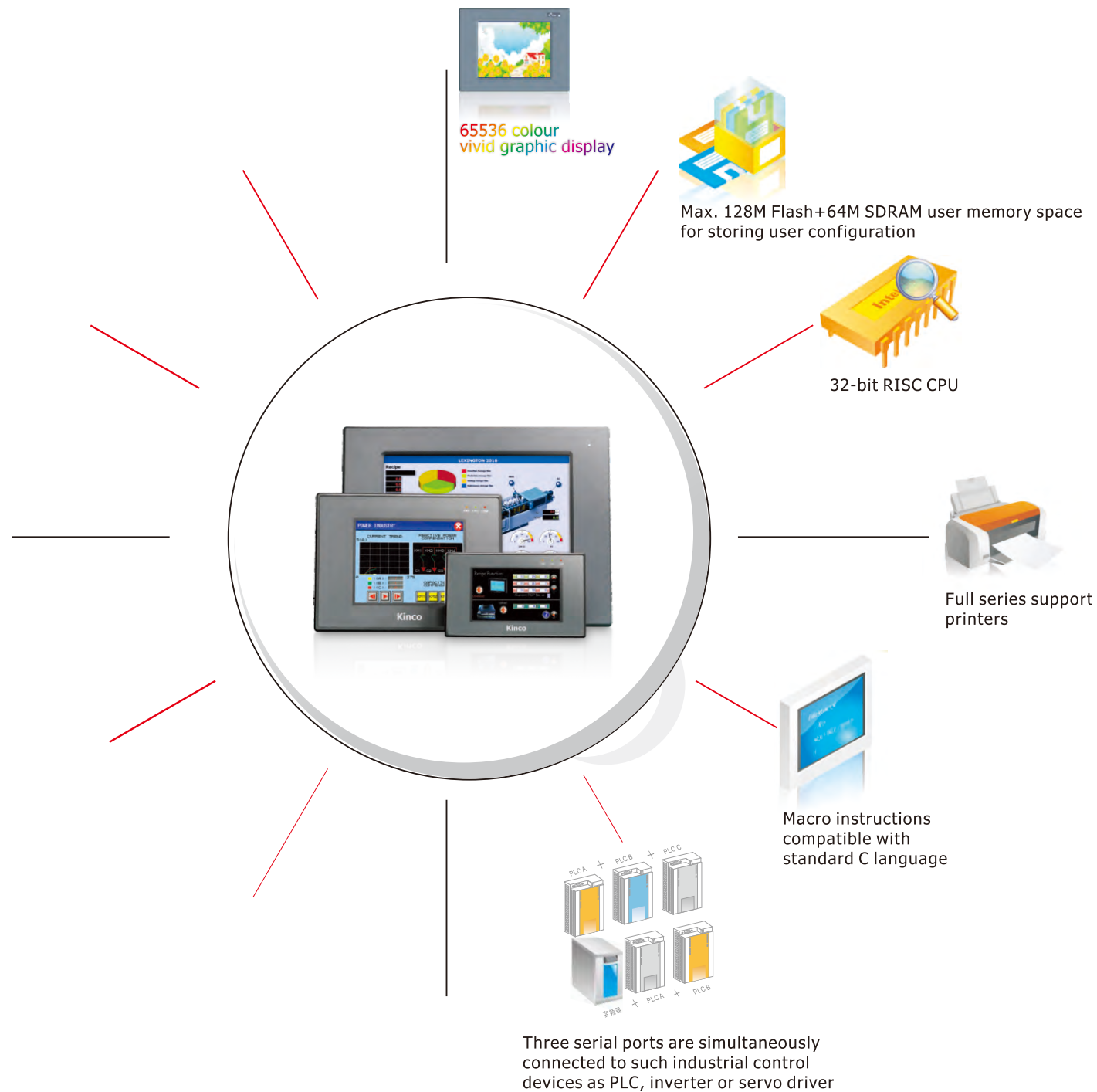

Hardware Description

Standard configuration | Three high-speed serial ports
One USB SLAVE port

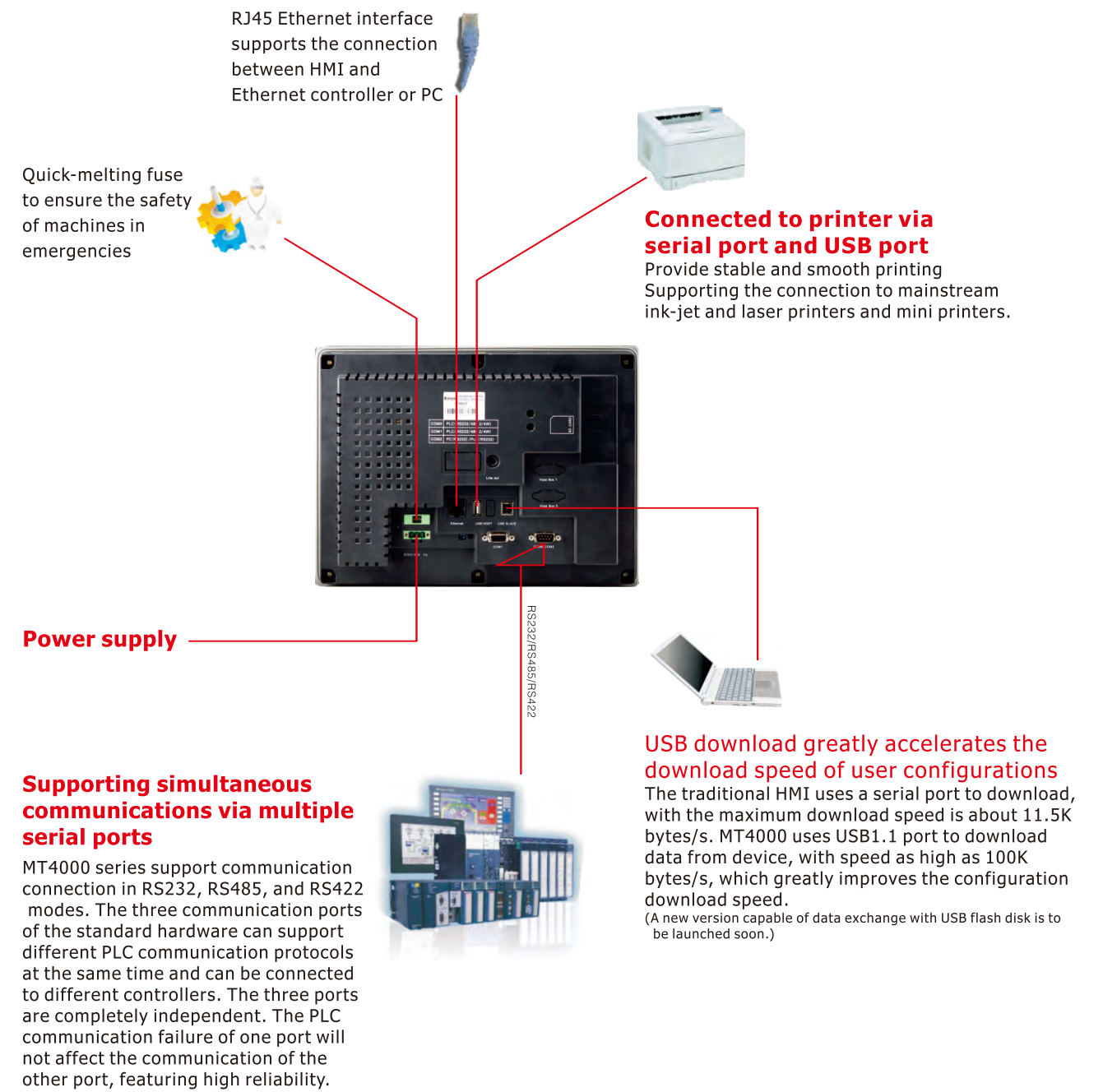

MT4000 Series Features



- 10M/100M Ethernet interface, supports Ethernet communication based on CS structure, could be used for the setting of system parameters and online simulation of project configuration, multiple HMIs could be linked via Ethernet, could communicate with PC and PLC via Ethernet interface, could exchange data with controller which supports Ethernet communication via OPC software (only applicable to MT4000E series);
- 65536 true color TFT LCD, supports the import multiple windows image formats, such as BMP, JPG, GIF; supports all fonts of windows platform, supports 4 languages of interface display;
- 32-bit, 400MHz, up to 800MHz RISC CPU;
- 128M Max. FLASH ROM + 64M Max. SDRAM/DDR, larger storage space;
- Compatible with major PLCs and controllers, could provide customer-made communication drive program rapidly;
- Max. 512KB recipe memory, could record data easily, convenient for user to inquire;
- Supports the timing of a minimum of 100ms, configured with multiple functions such as timing data transfer, value accumulation, decrease and macro instruction;
- Real-time clock, could reserve time for more than 2 years at power-off state;
- 3 COM ports, supports simultaneous communications with controllers of 3 different protocols, supports RS232/RS422/RS485 mode;
- 1 USB SLAVE port, greatly accelerates the download speed of user configuration;
- Connect to printer via serial port and USB port;
- Powerful configuration software-Kinco HMIware supports macro commands and provides rich drawing library.

MT4000 Series Technical Specifications



MT4210T



MT4220TE

Model	MT4210T	MT4220TE
Performance specification		
Display	4.3" TFT	
Resolution	480×272 pixels	
Color	65536 colors	
Backlight	LED	
Brightness	300cd/m ²	
Backlight life	50000 hr.	
Touch Panel	4-wire precision resistance network	
Processor	32-bit RISC CPU 400MHz	32-bit RISC CPU 800MHz
Memory	128M FLASH + 64M SDRAM	
Expandable memory	None	1 USB host, 1 SD card
Recipe memory & RTC	512KB + RTC	
Printer port	Serial port	Serial port/USB port
Ethernet	None	Support
Program download	USB SLAVE/Serial port	USB SLAVE/Serial port/Ethernet port
COM port	COM0:RS232/RS485-2/RS485-4, COM2:RS232	
Electrical specification		
Rated power	4.8 W	
Rated voltage	DC24V	
Input range	12~28VDC	
Power down allowed	<5ms	
Insulation resistance	Greater than 50MΩ @ 500V DC	
Dielectric strength test	500VAC 1 minute	
Structure specification		
Shell color	Black	
Shell material	ABS	
Dimensions(mm)	154×89×60	
Cutout size(mm)	145×81	
Weight	0.34kg	
Environment specification		
Operating temperature	-20~55℃	
Operating humidity	10~90% non-condensing	
Storage temperature	-25~60℃	
Storage humidity	10~90% non-condensing	
Shockproof test	10~25Hz (X, Y, Z direction, 2G, 30 minutes)	
Cooling method	Natural air cooling	
Certification		
Degree of protection	IP65 (front panel)	
CE certification	Comply with EN61000-6-2:2005 and EN61000-6-4:2007standards	
FCC compatibility	Complies with FCC Class A	
UL certification	Comply with UL 508	None

MT4000 Series

Technical Specifications



MT4300C/MT4300CE

Model	MT4300C	MT4300CE
Performance specification		
Display	5.6" TFT	
Resolution	320×234 pixels	
Color	65536 colors	
Backlight	LED	
Brightness	300cd/m ²	
Backlight life	50000 hr.	
Touch Panel	4-wire precision resistance network	
Processor	32-bit RISC CPU 400MHz	32-bit RISC CPU 800MHz
Memory	128M Flash+64M SDRAM	
Expandable memory	None	
Recipe memory & RTC	512KB & RTC	
Printer port	Serial port	
Ethernet	None	Support
Program download	USB SLAVE/ Serial port	USB SLAVE/Serial port/ Ethernet port
COM port	COM0:RS232/RS485-2/RS485-4, COM1:RS232/RS485-2/RS485-4, COM2:RS232	
Electrical specification		
Rated power	4 W	
Rated voltage	DC24V	
Input range	12~28VDC	
Power down allowed	<5ms	
Insulation resistance	Greater than 50MΩ @ 500V DC	
Dielectric strength test	500V AC 1 minute	
Structure specification		
Shell color	Black	
Shell material	ABS	
Dimensions(mm)	204×150×52	
Cutout size(mm)	192×138	
Weight	0.85kg	
Environment specification		
Operating temperature	0~50℃	
Operating humidity	10~90% non-condensing	
Storage temperature	-10~60℃	
Storage humidity	10~90% non-condensing	
Shockproof test	10~25Hz (X, Y, Z direction, 2G, 30 minutes)	
Cooling method	Natural air cooling	
Certification		
Degree of protection	IP65 (front panel)	
CE certification	Comply with EN61000-6-2:2005 and EN61000-6-4:2007standards	
FCC compatibility	Complies with FCC Class A	

MT4000 Series

Technical Specifications



MT4404T/MT4424TE



MT4414T/MT4414TE
MT4414TE-CAN

Model	MT4404T	MT4414T	MT4414TE*	MT4424TE
Performance specification				
Display	7" 16:9 TFT			
Resolution	800×480 pixels			
Color	65536 colors			
Backlight	LED			
Brightness	300cd/m ²			
Backlight life	50000 hr.			
Touch Panel	4-wire precision resistance network			
Processor	32-bit RISC CPU 400MHz		32-bit RISC CPU 800MHz	
Memory	128M Flash+64M DDR2	128M FLASH+64M SDRAM		128M Flash+64M DDR2
Expandable memory	None	1 USB host		1 USB host, 1 SD card
Recipe memory & RTC	512KB & RTC			
Printer port	Serial port		USB/Serial port	
Ethernet	None	None	Support	Support
Program download	USB SLAVE/Serial port		USB SLAVE/Serial port/Ethernet port	
COM port	COM0:RS232/RS485-2/ RS485-4, COM1:RS232/ RS485-2/RS485-4, COM2:RS232	COM0:RS232/RS485-2/RS485-4, COM2:RS232		COM0:RS232/RS485-2/ RS485-4, COM1:RS232/ RS485-2/RS485-4, COM2:RS232
Electrical specification				
Rated power	8W	4W		8W
Rated voltage	DC24V			
Input range	21~28VDC, in-built isolated power supply.	12~28VDC		21~28VDC, in-built isolated power supply.
Power down allowed	<5ms	<3ms		<5ms
Insulation resistance	Greater than 50MΩ @ 500V DC			
Dielectric strength test	500V AC 1 minute			
Structure specification				
Shell color	Black			
Shell material	ABS			
Dimensions(mm)	206.8 × 124.2 × 45.1	204 × 150 × 37		206.8 × 124.2 × 45.1
Cutout size(mm)	193.5 × 112.5		192 × 138	
Weight	0.8kg	0.75kg		0.8kg
Environment specification				
Operating temperature	0~50℃			
Operating humidity	10~90% non-condensing			
Storage temperature	-10~60℃			
Storage humidity	10~90% non-condensing			
Shockproof test	10~25Hz (X, Y, Z direction, 2G, 30 minutes)			
Cooling method	Natural air cooling			
Certification				
Degree of protection	IP65 (front panel)			
CE certification	Comply with EN61000-6-2:2005 and EN61000-6-4:2007standards			
FCC compatibility	Complies with FCC Class A			
UL certification	None		Comply with UL 508	

* **MT4414TE-CAN** with CANopen interface, other specifications are same with MT4414TE.

MT4000 Series

Technical Specifications



MT4403T/MT4403TE



MT4512T/MT4512TE
MT4522T/MT4522TE

Model	MT4403T	MT4403TE	MT4512T	MT4512TE	MT4522T	MT4522TE
Performance specification						
Display	8" TFT		10.1" 16:9 TFT		10.1" 16:9 TFT	
Resolution	800 × 600 pixels		800 × 480 pixels		800 × 480 pixels	
Color	65536 colors		65536 colors		65536 colors	
Backlight	LED		LED		LED	
Brightness	250cd/m ²		320cd/m ²		320cd/m ²	
Backlight life	50000 hr.					
Touch Panel	4-wire precision resistance network					
Processor	32-bit RISC CPU 400MHz			32-bit RISC CPU 800MHz		
Memory	128M FLASH+64M SDRAM					
Expandable memory	None		1 USB host		1 USB Host, 1 SD Card	
Recipe memory & RTC	256KB & RTC		512KB & RTC		512KB & RTC	
Printer port	Serial port		Serial port		USB/Serial port	
Ethernet	None	Support	None	Support	None	Support
Program download	USB SLAVE/ Serial port	USB SLAVE/ Serial port/ Ethernet port	USB SLAVE/ Serial port	USB SLAVE/ Serial port/ Ethernet port	USB SLAVE/ Serial port	USB SLAVE/ Serial port/ Ethernet port
COM port	COM0:RS232/RS485-2/RS485-4, COM1:RS232/RS485-2/RS485-4, COM2:RS232		COM0:RS232/RS485-2/RS485-4, COM2:RS232		COM0:RS232/RS485-2/RS485-4, COM1:RS232/RS485-2/RS485-4, COM2:RS232	
Electrical specification						
Rated power	8W		8W		5.5W	
Rated voltage	DC24V		DC24V		DC24V	
Input range	12~28VDC, in-built isolated power supply.		12~28VDC		21~28VDC	
Power down allowed	<5ms					
Insulation resistance	Greater than 50MΩ@ 500V DC					
Dielectric strength test	500V AC 1 minute					
Structure specification						
Shell color	Black		Black		Black	
Shell material	ABS		ABS		ABS	
Dimensions(mm)	235 × 172 × 53		310 × 230 × 55		310 × 230 × 55	
Cutout size(mm)	224 × 161		298 × 218		298 × 218	
Weight	1.3kg		2kg		1.47kg	
Environment specification						
Operating temperature	-10~50℃		0~50℃		0~50℃	
Operating humidity	10~90% non-condensing					
Storage temperature	-20~60℃		-10~60℃		-10~60℃	
Storage humidity	10~90% non-condensing					
Shockproof test	10~25Hz (X, Y, Z direction, 2G, 30 minutes)					
Cooling method	Natural air cooling					
Certification						
Degree of protection	IP65 (front panel)					
CE certification	Comply with EN61000-6-2:2005 and EN61000-6-4:2007standards					
FCC compatibility	Complies with FCC Class A					

MT4000 Series

Technical Specifications



MT4513T/MT4513TE
MT4523T/MT4523TE



MT4620TE

Model	MT4513T	MT4513TE	MT4523T	MT4523TE	MT4620TE
Performance specification					
Display	10.4" TFT		10.4" TFT		12.1" TFT
Resolution	800 × 600 pixels		800 × 600 pixels		800 × 600 pixels
Color	65536 colors		65536 colors		65536 colors
Backlight	LED		LED		LED
Brightness	300cd/m ²		300cd/m ²		450cd/m ²
Backlight life	50000 hr.				
Touch Panel	4-wire precision resistance network				
Processor	400MHz RISC	800MHz RISC	520MHz RISC		800MHz RISC
Memory	128M FLASH+64M DDR2		128M FLASH+64M SDRAM		128M FLASH+ 64M DDR
Expandable memory	None	1 USB HOST	1 SD Card, 1 USB HOST		1 SD Card, 1 USB HOST
Recipe memory & RTC	512KB & RTC		256KB & RTC		128KB & RTC
Printer port	Serial port	USB SLAVE/ Serial port	USB SLAVE/Serial port		USB SLAVE/Serial port/ Ethernet port
Ethernet	None	Support	None	Support	Support
Program download	USB SLAVE/ Serial port	USB SLAVE/ Serial port/ Ethernet port	USB SLAVE/ Serial port	USB SLAVE/ Serial port/ Ethernet port	USB SLAVE/ Serial port/ Ethernet port
COM port	COM0:RS232/RS485-2/RS485-4, COM2:RS232		COM0:RS232/RS485-2/RS485-4, COM1:RS232/RS485-2/RS485-4, COM2:RS232		
Electrical specification					
Rated power	8 W		12 W		10 W
Rated voltage	DC24V		DC24V		DC24V
Input range	10~28VDC		21~28VDC, in-built isolated power supply.		
Power down allowed	<5ms				<3ms
Insulation resistance	Greater than 50MΩ@ 500V DC				
Dielectric strength test	500V AC 1 minute				
Structure specification					
Shell color	Dark gray		Black		Cold gray
Shell material	PC+ABS		ABS		PC
Dimensions(mm)	310 × 230 × 55		310 × 230 × 55		350 × 260 × 54
Cutout size(mm)	298 × 218		298 × 218		340 × 250
Weight	2kg		2kg		2kg
Environment specification					
Operating temperature	0~50℃		0~50℃		-10~55℃
Operating humidity	10~90% non-condensing				
Storage temperature	-10~60℃		-10~60℃		-20~60℃
Storage humidity	10~90% non-condensing				
Shockproof test	10~25Hz (X, Y, Z direction, 2G, 30 minutes)				
Cooling method	Natural air cooling				
Certification					
Degree of protection	IP65 (front panel)				
CE certification	Comply with EN61000-6-2:2005 and EN61000-6-4:2007standards				
FCC compatibility	Complies with FCC Class A				

Dimensions (Unit:mm)

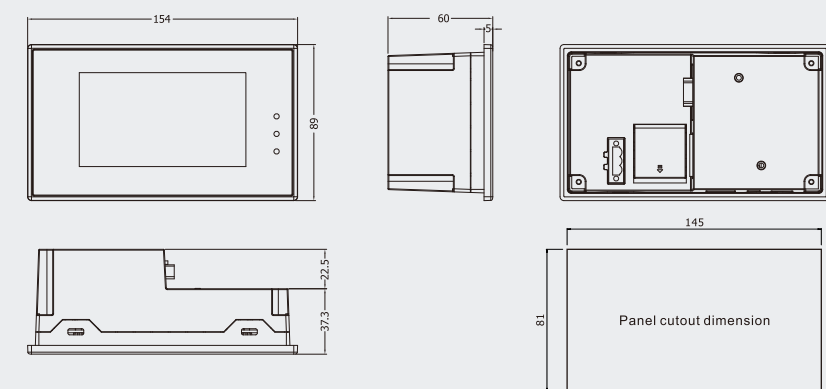
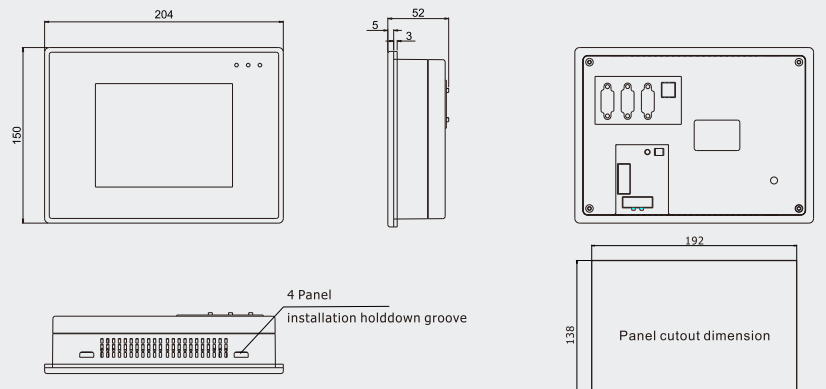
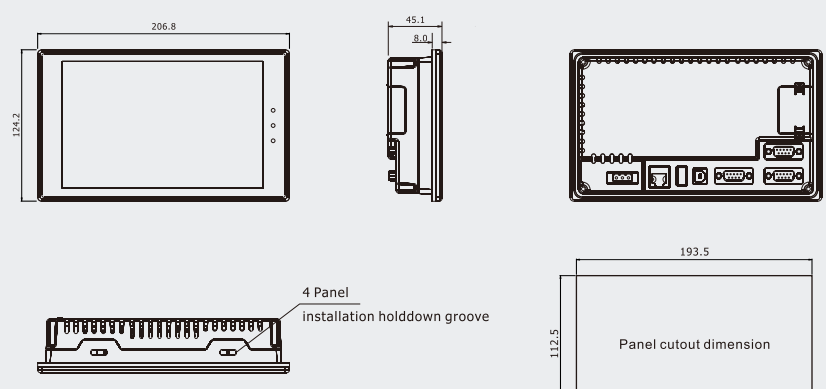
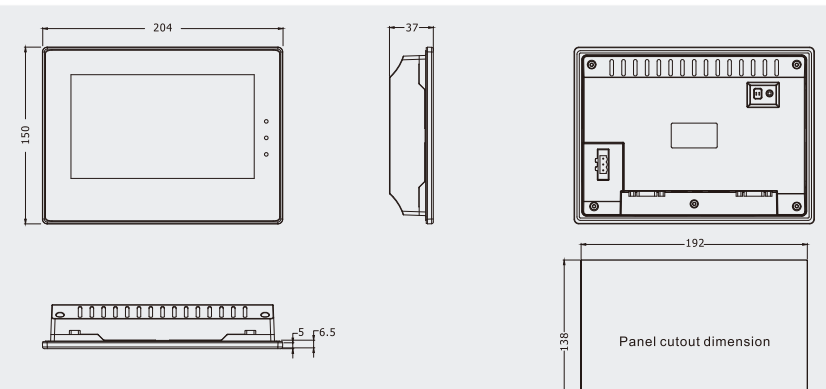
<p>MT4210T MT4220TE</p>	
<p>MT4300C MT4300CE</p>	
<p>MT4404T MT4424TE</p>	
<p>MT4414T MT4414TE MT4414TE-CAN</p>	

Dimensions (Unit:mm)

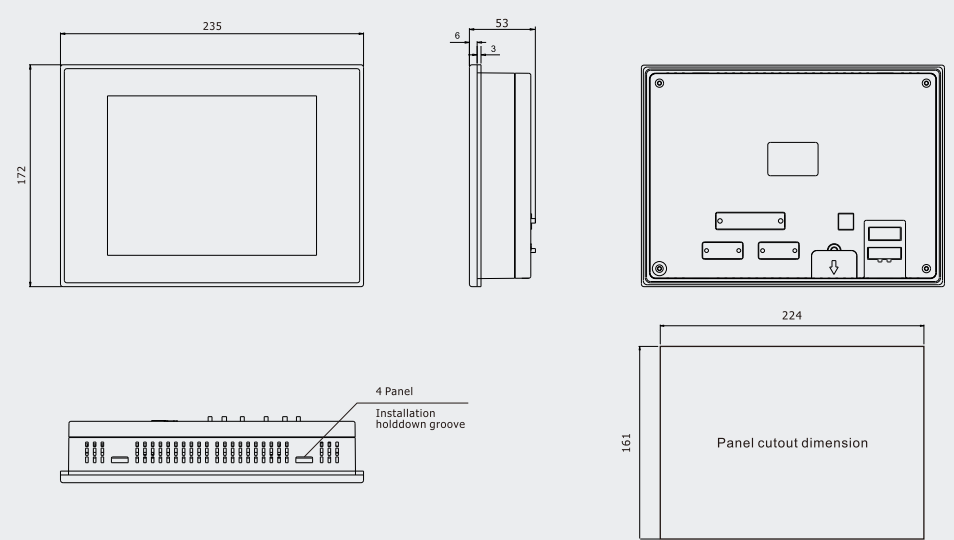
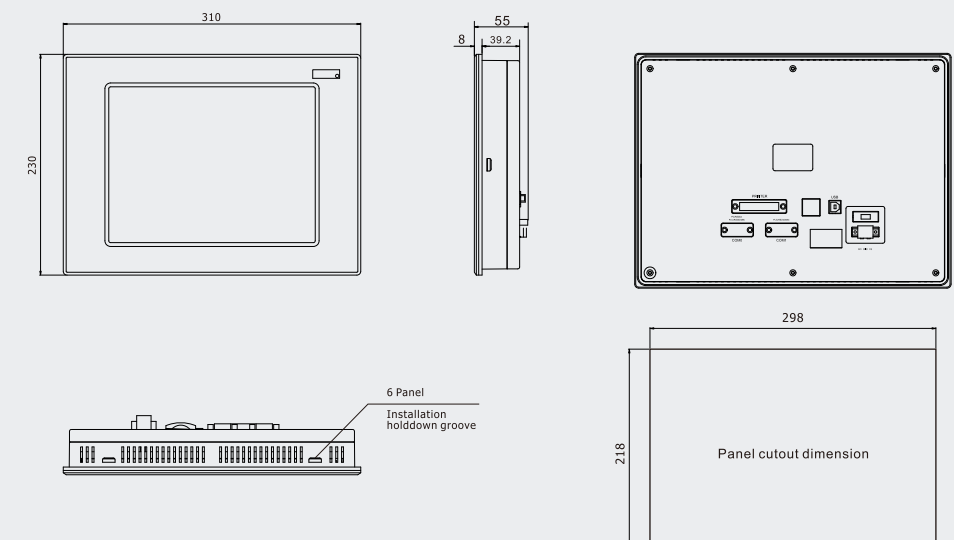
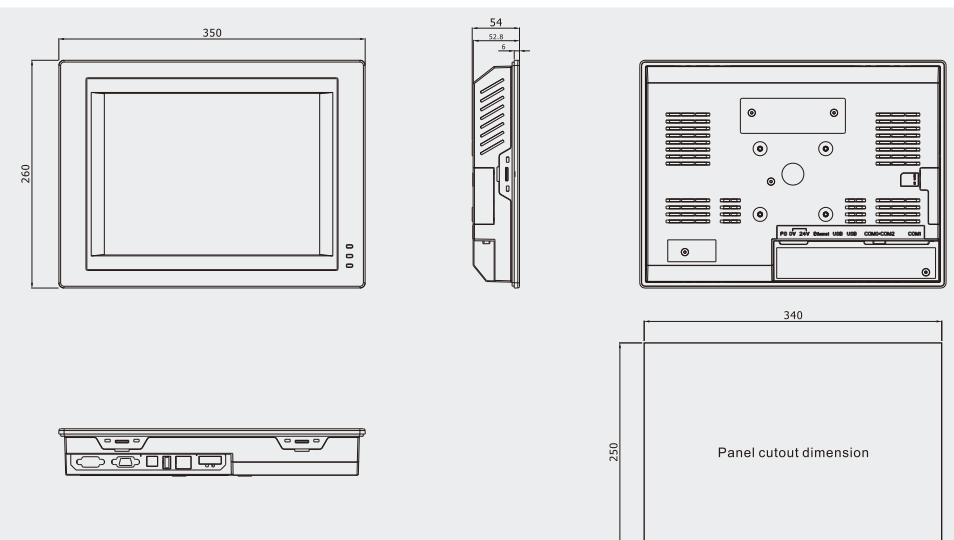
<p>MT4403T MT4403TE</p>	
<p>MT4512T MT4512TE MT4522T MT4522TE MT4513T MT4513TE MT4523T MT4523TE</p>	
<p>MT4620TE</p>	

System Description

MT5000 series HMI use INTEL 520MHz RISC CPU and LINUX operating system, have the easy learning configuration software, maintain the classic HMI design. It supports USB HOST function and SD card, and could manage data and preserve parameters online, you can quickly up/download user programs, and integrate the audio output; MT5000 series HMI integrate industry Ethernet and Fieldbus interface, could be linked with other screens in eView protocol, could communicate with other controllers via Ethernet interface in MODBUS TCP/IP protocol, could exchange data with controller via OPC software, could extend CANopen communication card and Profibus-DP communication card, connecting to the field bus network.

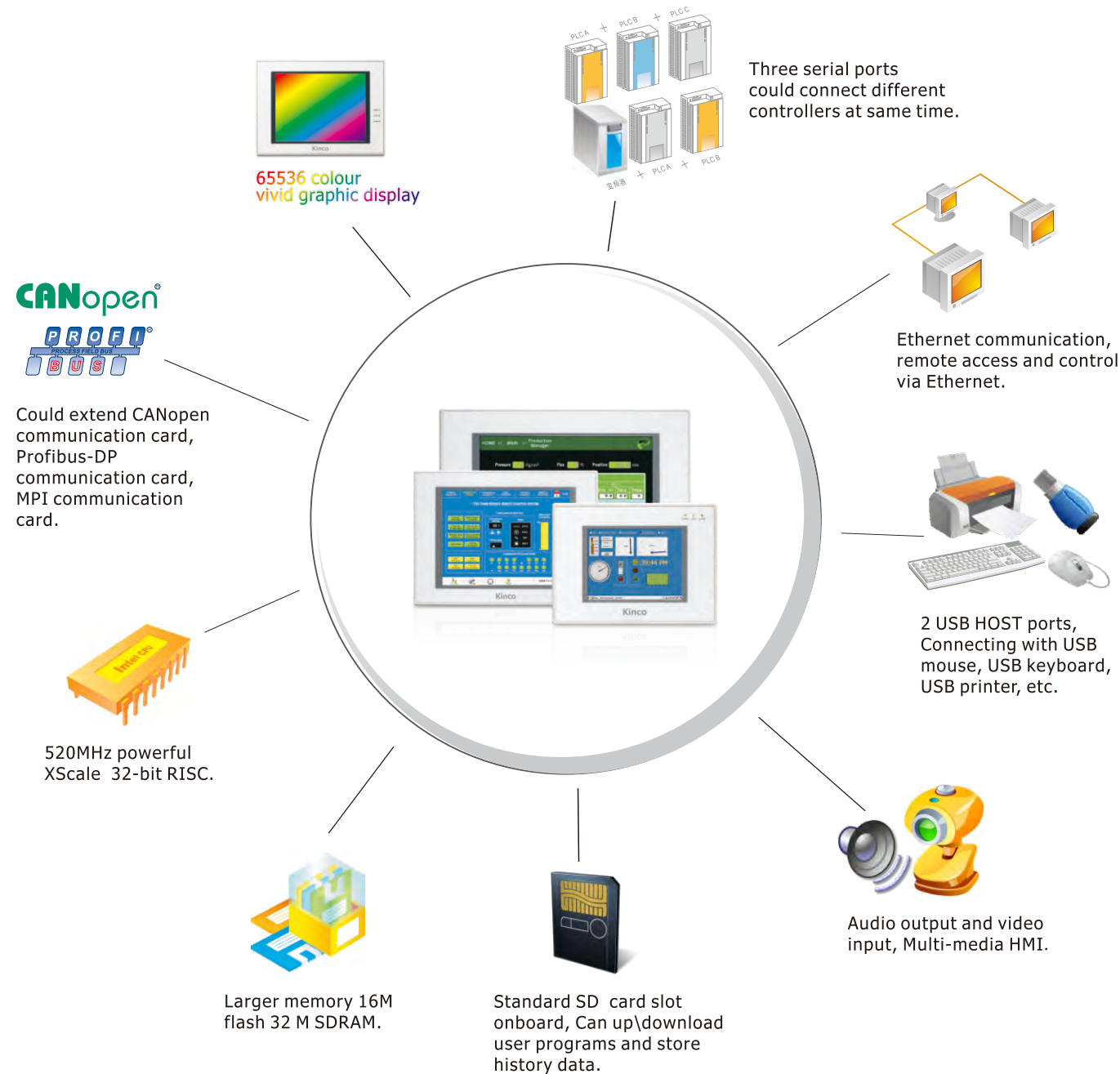

Hardware Description

Standard Configuration:

- Three RS-232/485/422 ports
- Two USB-HOST ports
- One USB SLAVE port
- One Ethernet Interface
- One Audio Output Interface
- Two Video input interface
- One SD Card

Expandable Configuration:

- Profibus-DP Communication Card
- CANopen Communication Card
- MPI Communication Card

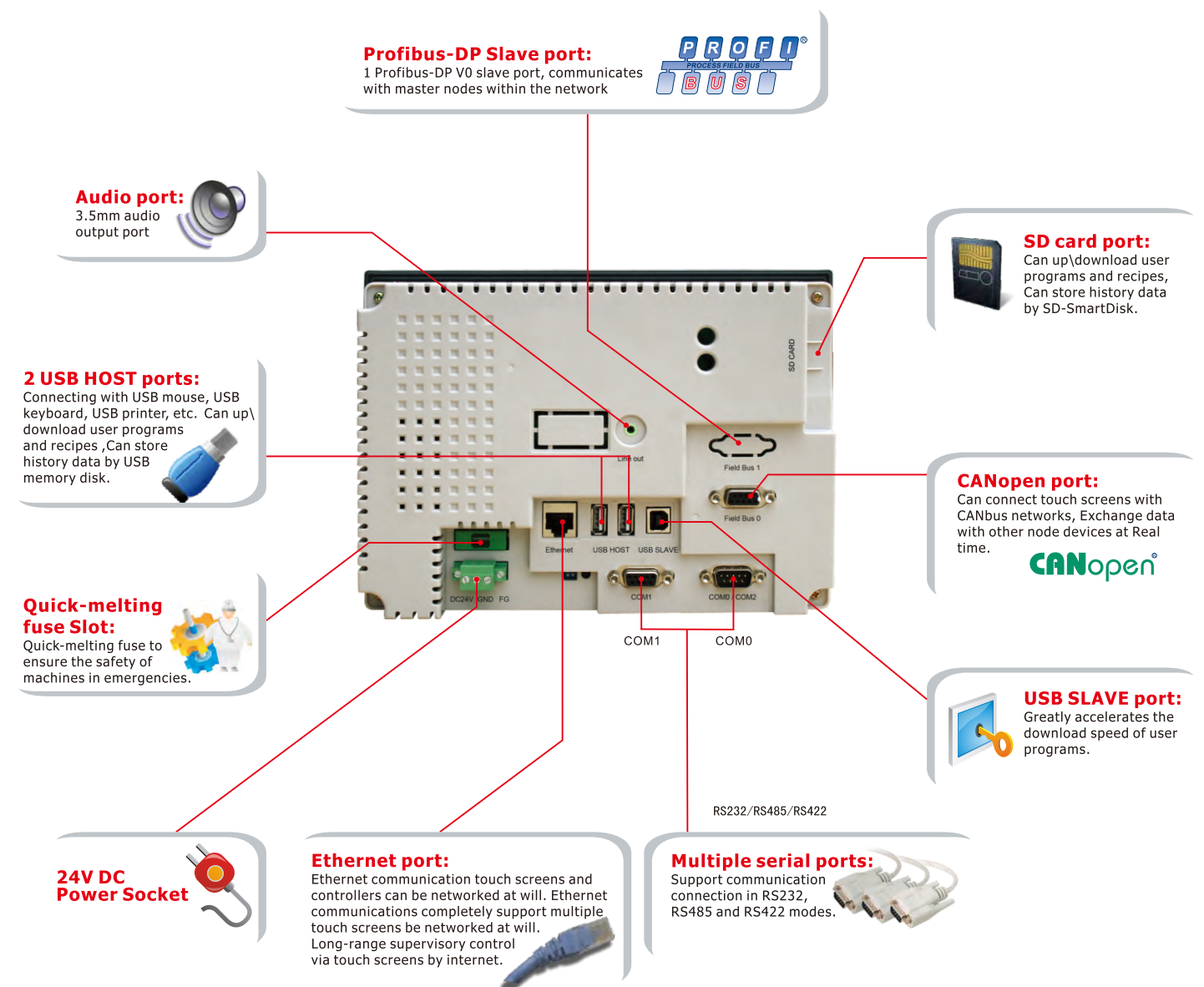

MT5000 Series Features



- Higher performance and efficiency thanks to the 520MHz powerful XScale® 32-bit RISC processor;
- Larger and expansible memory for more complicated user application and data storage;
- Dual USB host ports compatible with peripherals like mouse, keyboard, printer and USB disk. Users can upload/download application and recipes data from/to the panel by using USB disk. Historical data can also be stored in the USB disk;
- Standard SD® card slot onboard
Just like the USB disk, SD® card can be used for uploading/downloading application and recipes data from/to the panel. Also, historical data can be stored in the card;
- 3.5mm audio output port for external speaker;
- 10.4 above models support two-channel PAL video input interface, they can be used real-time monitoring on industrial fields;
- RJ45 Ethernet interface through which the panel can communicate with controllers and other panels, users can remotely get access to the panel via the internet also, Via Kinco OPC software, user can realize factory automation network monitoring;
- Optional CANopen interface makes it possible for using the panel as a CAN node. With proper drivers, the panel can be used as a host or client. With MT5020, you CAN;
- The panel can exchange data with Profibus-DP node with the optional Profibus interface;
- With optional MPI interface, the panel can communicate with Siemens S7-300/400 without any costly adapters;
- 1 USB slave port for downloading application data from the PC faster than via serial port;
- 65536 color TFT LCD ensures vivid graphic display, supports the import multiple windows image formats, such as BMP, JPG, GIF; supports all fonts of windows platform, supports 4 languages of interdate display;
- 3 COM ports, supports simutaneous communications with controllers of 3 different protocols, supports RS232/RS422/RS485 modes, supports exchange serial ports by software.

MT5000 Series Technical Specifications



Model	MT5320C	MT5320C -DP	MT5320C -CAN	MT5320C -MPI	MT5323T	MT5323T -DP	MT5323T -CAN	MT5323T -MPI
Performance specification								
Display	5.6" TFT				5.7" TFT			
Resolution	320 × 234 pixels				640 × 480 pixels			
Color	65536 colors				65536 colors			
Backlight	LED				LED			
Brightness	300cd/m ²				700cd/m ²			
Backlight life	50000 hr.				50000 hr.			
Touch Panel	4-wire precision resistance network				4-wire precision resistance network			
Processor	32-bit RISC CPU 520MHz				32-bit RISC CPU 520MHz			
Memory	8M FLASH+16M SDRAM				16M FLASH+32M SDRAM			
Recipe memory & RTC	512KB & RTC				512KB & RTC			
Expandable memory	1 SD Card (≤2GB) , 2 USB HOST				1 SD Card (≤2GB) , 2 USB HOST			
Printer port	USB/Serial port				USB/Serial port			
Ethernet	10/100 Base-T				10/100 Base-T			
Audio interface	None				None			
Vedio interface	None				None			
Program download	1 USB SLAVE port/Serial port/Ethernet port				1 USB SLAVE port/Serial port/Ethernet port			
COM port	COM0:RS232/RS485-2/RS485-4, COM1:RS232/RS485-2/RS485-4, COM2:RS232				COM0:RS232/RS485-2/RS485-4, COM1:RS232/RS485-2/RS485-4, COM2:RS232			
Expansion port	None	Profibus-DP	CANopen	MPI	None	Profibus-DP	CANopen	MPI
Electrical specification								
Rated power	7.2 W				10 W			
Rated voltage	DC24V				DC24V			
Input range	21~28VDC				12~28VDC			
Momentary power-off	<3ms				<3ms			
Insulation resistance	Greater than 50MΩ@ 500V DC				Greater than 50MΩ@ 500V DC			
Dielectric strength test	500V AC 1 minute				500V AC 1 minute			
Structure specification								
Shell color	Light-gray				Light-gray			
Shell material	ABS				ABS			
Dimensions(mm)	204 × 150 × 56.7				204 × 150 × 56.7			
Cutout size(mm)	192 × 138				192 × 138			
Weight	0.96kg				0.96kg			
Environment specification								
Operating temperature	0~45℃				-20~70℃			
Operating humidity	10~90% non-condensing				10~90% non-condensing			
Storage temperature	-30~80℃				-30~80℃			
Storage humidity	10~90% non-condensing				10~90% non-condensing			
Shockproof test	10~25Hz (X, Y, Z direction, 2G, 30 minutes)				10~25Hz (X, Y, Z direction, 2G, 30 minutes)			
Cooling method	Natural air cooling				Natural air cooling			
Certification								
Degree of protection	IP65 (front panel)				IP65 (front panel)			
CE certification	Comply with EN61000-6-2:2005 and EN61000-6-4:2007standards				Comply with EN61000-6-2:2005 and EN61000-6-4:2007standards			
FCC compatibility	Complies with FCC Class A				Complies with FCC Class A			

MT5000 Series

Technical Specifications

MT5000

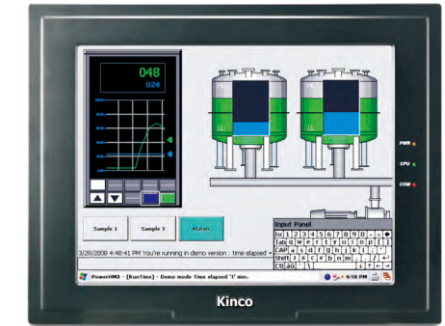

MT5000

Model	MT5423T	MT5423T -DP	MT5423T -CAN	MT5423T -MPI	MT5520T	MT5520T -DP	MT5520T -CAN	MT5520T -MPI
Performance specification								
Display	8" TFT				10.4" TFT			
Resolution	800 × 600 pixels				640 × 480 pixels			
Color	65536				65536			
Backlight	LED				2 CCFL			
Brightness	300cd/m ²				400cd/m ²			
Backlight life	50000 hr.				50000 hr.			
Touch Panel	4-wire precision resistance network				4-wire precision resistance network			
Processor	32-bit RISC CPU 520MHz				32-bit RISC CPU 520MHz			
Memory	16M FLASH+32M SDRAM				16M FLASH+32M SDRAM			
Recipe memory & RTC	512KB & RTC				512KB & RTC			
Expandable memory	1 SD Card (≤2GB) , 2 USB HOST				1 SD Card (≤2GB) , 2 USB HOST			
Printer port	USB/Serial port				USB/Serial port			
Ethernet	10/100 Base-T				10/100 Base-T			
Audio interface	1 Audio output interface				1 Audio output interface			
Vedio interface	None				None			
Program download	1 USB SLAVE port/Serial port/Ethernet port				1 USB SLAVE port/Serial port/Ethernet port			
COM port	COM0:RS232/RS485-2/RS485-4, COM1:RS232/RS485-2/RS485-4, COM2:RS232				COM0:RS232/RS485-2/RS485-4, COM1:RS232/RS485-2/RS485-4, COM2:RS232			
Expansion port	None	Profibus-DP	CANopen	MPI	None	Profibus-DP	CANopen	MPI
Electrical specification								
Rated power	8 W				12 W			
Rated voltage	DC24V				DC24V			
Input range	12~28VDC				21~28VDC			
Momentary power-off	<3ms				<3ms			
Insulation resistance	Greater than 50MΩ@ 500V DC				Greater than 50MΩ@ 500V DC			
Dielectric strength test	500V AC 1 minute				500V AC 1 minute			
Structure specification								
Shell color	Light-gray				Light-gray			
Shell material	ABS				ABS			
Dimensions(mm)	235 × 172 × 57.9				310.6 × 230.6 × 55.7			
Cutout size(mm)	224 × 161				298 × 218			
Weight	1.27kg				2kg			
Environment specification								
Operating temperature	0~45℃				0~45℃			
Operating humidity	10~90% non-condensing				10~90% non-condensing			
Storage temperature	-10~60℃				-10~60℃			
Storage humidity	10~90% non-condensing				10~90% non-condensing			
Shockproof test	10~25Hz (X, Y, Z direction, 2G, 30 minutes)				10~25Hz (X, Y, Z direction, 2G, 30 minutes)			
Cooling method	Natural air cooling				Natural air cooling			
Certification								
Degree of protection	IP65 (front panel)				IP65 (front panel)			
CE certification	Comply with EN61000-6-2:2005 and EN61000-6-4:2007standards				Comply with EN61000-6-2:2005 and EN61000-6-4:2007standards			
FCC compatibility	Complies with FCC Class A				Complies with FCC Class A			

Model	MT5620T	MT5620T -DP	MT5620T -CAN	MT5620T -MPI	MT5720T	MT5720T -DP	MT5720T -CAN	MT5720T -MPI
Performance specification								
Display	12.1" TFT				15" TFT			
Resolution	800 × 600 pixels				1024 × 768 pixels			
Color	65536				65536			
Backlight	2 CCFL				2 CCFL			
Brightness	250cd/m ²				250cd/m ²			
Backlight life	50000 hr.				50000 hr.			
Touch Panel	4-wire precision resistance network				4-wire precision resistance network			
Processor	32-bit RISC CPU 520MHz				32-bit RISC CPU 520MHz			
Memory	16M FLASH+32M SDRAM				16M FLASH+32M SDRAM			
Recipe memory & RTC	512KB & RTC				512KB & RTC			
Expandable memory	1 SD Card (≤2GB) , 2 USB HOST				1 SD Card (≤2GB) , 2 USB HOST			
Printer port	USB/Serial port				USB/Serial port			
Ethernet	10/100 Base-T				10/100 Base-T			
Audio interface	1 Audio output interface				1 Audio output interface			
Vedio interface	2 PAL signal video input interface,BNC connector				2 PAL signal video input interface,BNC connector			
Program download	1 USB SLAVE port/Serial port/Ethernet port				1 USB SLAVE port/Serial port/Ethernet port			
COM port	COM0:RS232/RS485-2/RS485-4, COM1:RS232/RS485-2/RS485-4, COM2:RS232				COM0:RS232/RS485-2/RS485-4, COM1:RS232/RS485-2/RS485-4, COM2:RS232			
Expansion port	None	Profibus-DP	CANopen	MPI	None	Profibus-DP	CANopen	MPI
Electrical specification								
Rated power	15.6 W				16.8 W			
Rated voltage	DC24V				DC24V			
Input range	21~28VDC				21~28VDC			
Momentary power-off	<3ms				<3ms			
Insulation resistance	Greater than 50MΩ@ 500V DC				Greater than 50MΩ@ 500V DC			
Dielectric strength test	500V AC 1 minute				500V AC 1 minute			
Structure specification								
Shell color	Black				Black			
Shell material	Metal				Metal			
Dimensions(mm)	350 × 264 × 48.7				406.5 × 313.5 × 48.3			
Cutout size(mm)	327 × 241				387.5 × 294.5			
Weight	4.3kg				5.1kg			
Environment specification								
Operating temperature	-10~60℃				0~50℃			
Operating humidity	10~90% non-condensing				10~90% non-condensing			
Storage temperature	-20~70℃				-20~60℃			
Storage humidity	10~90% non-condensing				10~90% non-condensing			
Shockproof test	10~25Hz (X, Y, Z direction, 2G, 30 minutes)				10~25Hz (X, Y, Z direction, 2G, 30 minutes)			
Cooling method	Natural air cooling				Natural air cooling			
Certification								
Degree of protection	IP65 (front panel)				IP65 (front panel)			
CE certification	Comply with EN61000-6-2:2005 and EN61000-6-4:2007standards				Comply with EN61000-6-2:2005 and EN61000-6-4:2007standards			
FCC compatibility	Complies with FCC Class A				Complies with FCC Class A			

Dimensions (Unit:mm)

MT5320C
MT5320C-DP
MT5320C-CAN
MT5320C-MPI

MT5323T
MT5323T-DP
MT5323T-CAN
MT5323T-MPI

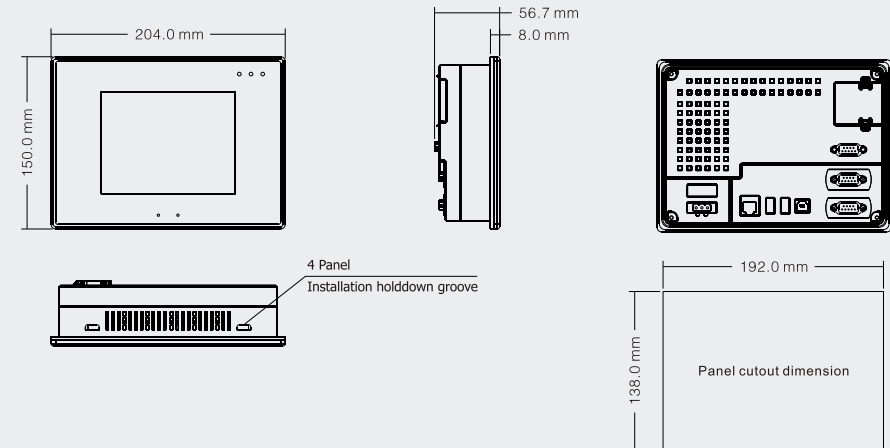

MT5423T
MT5423T-DP
MT5423T-CAN
MT5423T-MPI

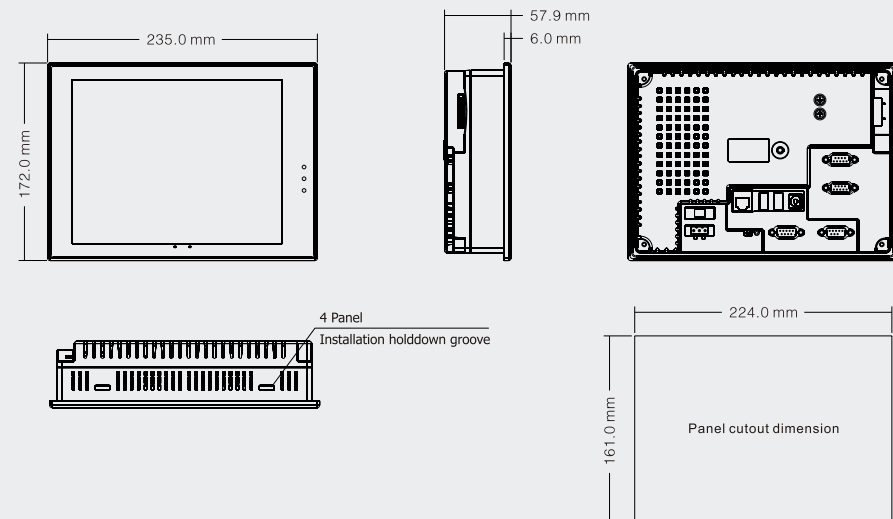

MT5520T
MT5520T-DP
MT5520T-CAN
MT5520T-MPI

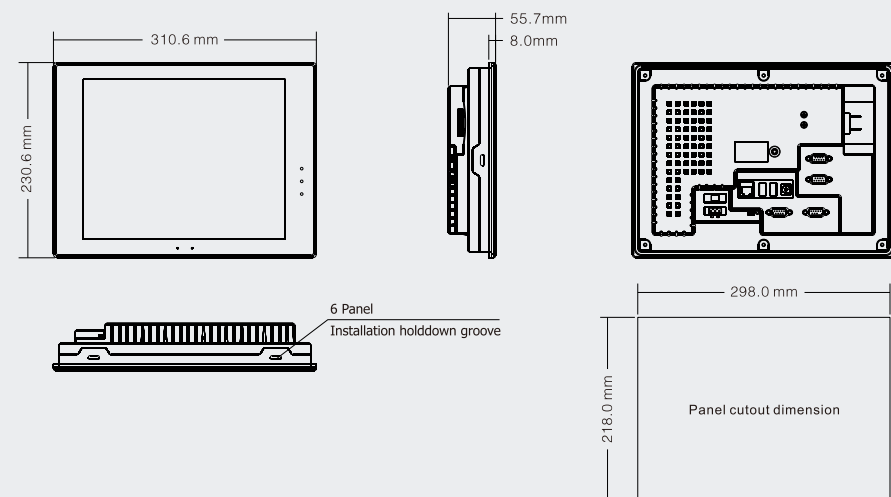

Dimensions (Unit:mm)

MT5620T
MT5620T-DP
MT5620T-CAN
MT5620T-MPI

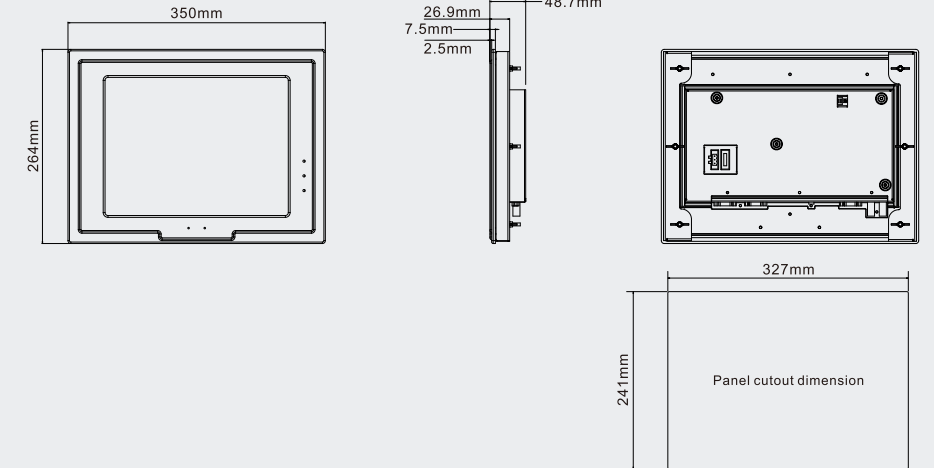

MT5720T
MT5720T-DP
MT5720T-CAN
MT5720T-MPI

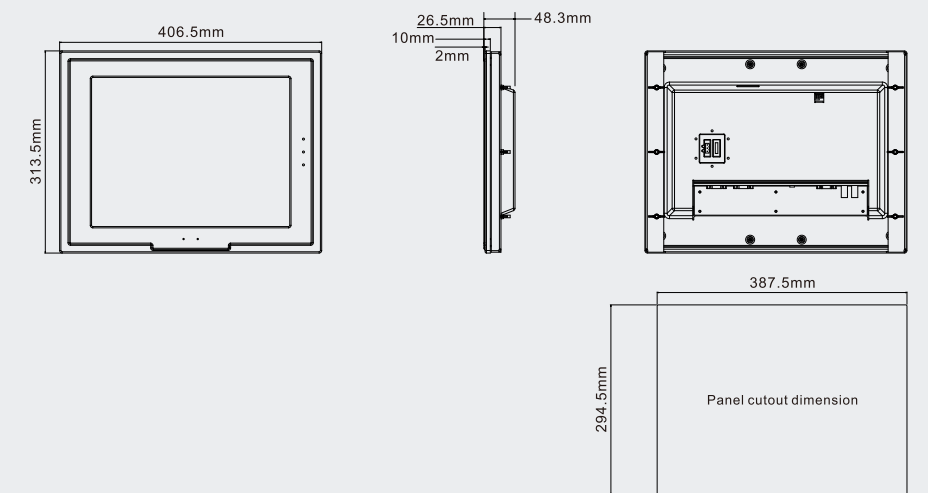

Text Display

MD200/300 Series

MD204L

4.3"

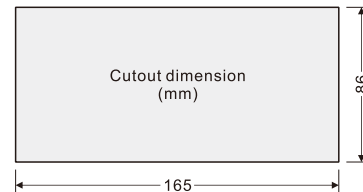

Shell color	Grey	Power supply	21~28VDC
Display	4.3" STN	Current	MAX 150mA@24V DC
Resolution	192×64 Pixel (Supporting display of 4lines 12 Chinese characters)	Interference immunity test	Voltage 1500Vp-p, Pulse cycle 1μs, duration 1μs
Color	Monochromatic	Dielectric strength	500V AC (1min)
Brightness	60cd/m ²	Isolation resistance	Exceed 10MΩ at 500V DC
Contrast	Adjustable by Potentiometer	Vibration endurance	10~25Hz (X, Y, Z Direction, 2G, 30 minutes)
Backlight	Long Service life Yellow/Green LED	Protection class	IP65 Front Panel
LCM life time	Greater than 50,000 Hours at 25±2°C, 65±10%RH	Operating temperature	0~50°C
Panel	Non-touch screen	Storage temperature	-20~70°C
CPU	8-bit processor	Operating humidity	20~90%RH (non-condensing)
Memory	64KB Flash ROM	Shell material	Engineering plastic ABS+PC
Recipe memory	None	Dimensions(W×H×D)	172×95×30 mm
RTC	None	Display size(W×H)	101×36 mm
Function key	20 keys, customizable (Including 10 Numeric Input Keys)	Panel cutout dimension	165×86 mm
COM port	COM0:PC RS232&PLC RS485/422&PLC RS232	Cooling method	Natural air cooling
CE	EN61000-6-2:2005, EN61000-6-4:2007	Weight	0.3 kg

Text Display

MD200/300 Series

MD224L

4.3"

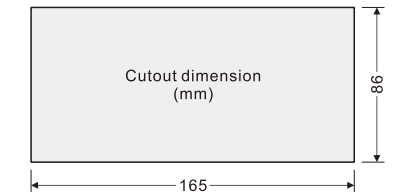
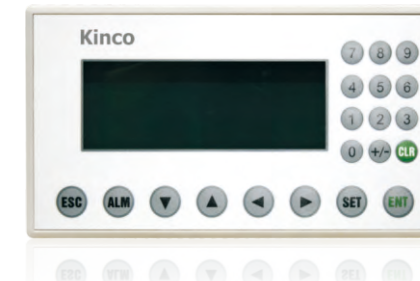

Shell color	Silver white	Power supply	21~28VDC
Display	4.3" STN	Current	MAX 150mA@24V DC
Resolution	192×64 Pixel (Supporting display of 4lines 12 Chinese characters)	Interference immunity test	Voltage 1500Vp-p, Pulse cycle 1μs, duration 1μs
Color	Monochromatic	Dielectric strength	500V AC (1min)
Brightness	60cd/m ²	Isolation resistance	Exceed 10MΩ at 500V DC
Contrast	Adjustable by Potentiometer	Vibration endurance	10~25Hz (X, Y, Z Direction, 2G, 30 minutes)
Backlight	Long Service life Yellow/Green LED	Protection class	IP65 Front Panel
LCM life time	Greater than 50,000 Hours at 25±2°C, 65±10%RH	Operating temperature	0~50°C
Panel	Non-touch screen	Storage temperature	-20~70°C
CPU	8-bit processor	Operating humidity	20~90%RH (non-condensing)
Memory	64KB Flash ROM	Shell material	Engineering plastic ABS+PC
Recipe memory	None	Dimensions(W×H×D)	172×95×30 mm
RTC	None	Display size(W×H)	101×36 mm
Function key	20 keys, customizable (Including 10 Numeric Input Keys)	Panel cutout dimension	165×86 mm
COM port	COM0:PC RS232&PLC RS485/422&PLC RS232	Cooling method	Natural air cooling
CE	EN61000-6-2:2005, EN61000-6-4:2007	Weight	0.3 kg

MD214L

4.3"

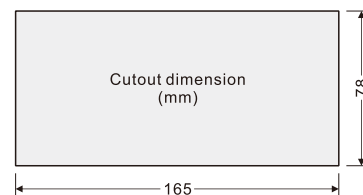

Shell color	Silver white	Power supply	21~28VDC
Display	4.3" FSTN	Current	MAX 150mA@24V DC
Resolution	192×64 Pixel (Supporting display of 4lines 12 Chinese characters)	Interference immunity test	Voltage 1500Vp-p, Pulse cycle 1μs, duration 1μs
Color	Monochromatic	Dielectric strength	500V AC (1min)
Brightness	97cd/m ²	Isolation resistance	Exceed 10MΩ at 500V DC
Contrast	Adjustable by Potentiometer	Vibration endurance	10~25Hz (X, Y, Z Direction, 2G, 30 minutes)
Backlight	White LED	Protection class	IP65 Front Panel
LCM life time	Greater than 50,000 Hours at 25±2°C, 65±10%RH	Operating temperature	0~50°C
Panel	Non-touch screen	Storage temperature	-20~70°C
CPU	8-bit processor	Operating humidity	20~90%RH (non-condensing)
Memory	64KB Flash ROM	Shell material	Engineering plastic ABS+PC
Recipe memory	None	Dimensions(W×H×D)	175×90×26 mm
RTC	None	Display size(W×H)	101×36 mm
Function key	19 keys, customizable (Including 10 Numeric Input Keys)	Panel cutout dimension	165×78 mm
COM port	COM0:PC RS232&PLC RS485/422&PLC RS232	Cooling method	Natural air cooling
CE	EN61000-6-2:2005, EN61000-6-4:2007	Weight	0.3 kg

MD304L

4.3"

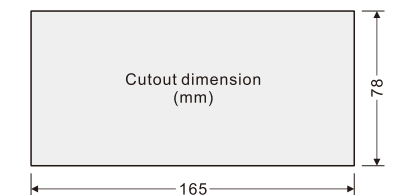

Shell color	Silver white	Power supply	21~28VDC
Display	4.3" FSTN	Current	MAX 150mA@24V DC
Resolution	192×64 Pixel (Supporting display of 4lines 12 Chinese characters)	Interference immunity test	Voltage 1500Vp-p, Pulse cycle 1μs, duration 1μs
Color	Monochromatic	Dielectric strength	500V AC (1min)
Brightness	97cd/m ²	Isolation resistance	Exceed 10MΩ at 500V DC
Contrast	Adjustable by Potentiometer	Vibration endurance	10~25Hz (X, Y, Z Direction, 2G, 30 minutes)
Backlight	White LED	Protection class	IP65 Front Panel
LCM life time	Greater than 50,000 Hours at 25±2°C, 65±10%RH	Operating temperature	0~50°C
Panel	Non-touch screen	Storage temperature	-20~70°C
CPU	8-bit processor	Operating humidity	20~90%RH (non-condensing)
Memory	64KB Flash ROM	Shell material	Engineering plastic ABS+PC
Recipe memory	2KB EEPROM	Dimensions(W×H×D)	175×90×26 mm
RTC	Accuracy 30PPM	Display size(W×H)	101×36 mm
Function key	19 keys, customizable (Including 10 Numeric Input Keys)	Panel cutout dimension	165×78 mm
COM port	COM0:PC RS232&PLC RS485/422&PLC RS232	Cooling method	Natural air cooling
CE	EN61000-6-2:2005, EN61000-6-4:2007	Weight	0.3 kg

Software Description

Kinco HMIware is suitable for MT4000/MT5000 series HMIs.

Operation window:

A simple and practical platform for project design and editing

- Completing all functions from editing components library and simulation compilation, to download;
- Browse various project information and make better adjustment in time.

Project file window

Facilitate in modifying components library

- Click an image library file, and the user can browse and edit the file;
- Visual understanding of the HMI quantity used.

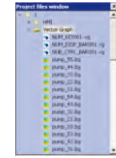

All windows can be dragged freely, and a user can create individualized operation interfaces according to his/her own habits.

Menu bar:

True color icon, visual and convenient navigation

- Familiar icon style for most users, easy to use;
- Simple and visual function.

Compilation information window

Display compilation progress

After compilation display, the user can download files.

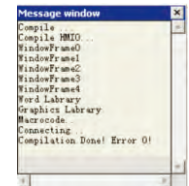

Components library window

Five components libraries, meeting design requirements



Project structure window

Master the conditions of the entire project

Master the HMI, HMI components and PLC type used for the entire project.

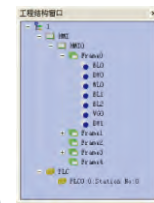

Software Description

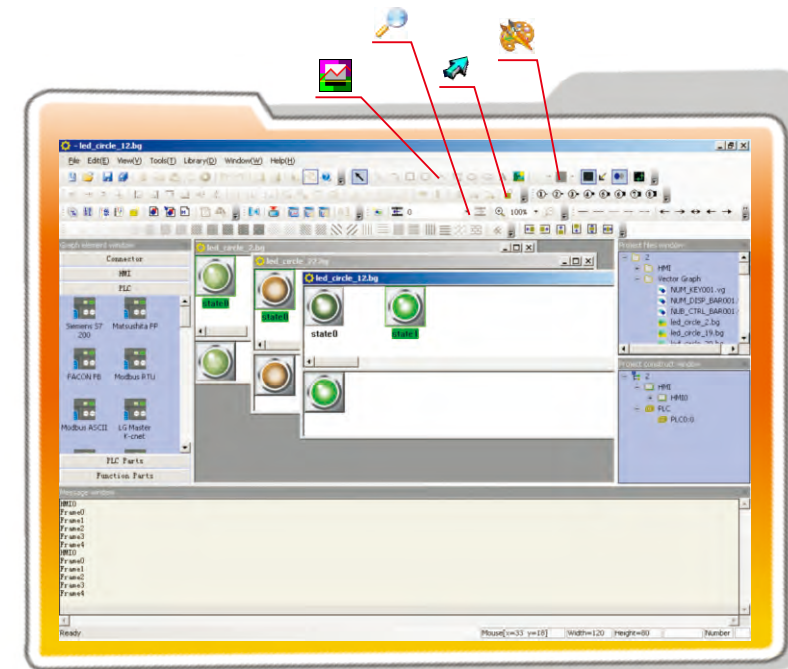

Powerful vector graphic function, supporting drawing of arcs, sectors, scales and pointers at any angle

- Eight line width options
- Three-level zoom-in/zoom-out display
- Supporting drawing of various vector-based image
- User-defined color filling in multiple modes

Password protection

16 different authority levels, authorized operators can execute necessary setting and operations according to their authority level. The security performance of the system is greatly enhanced.

Multi-language application environment

Any language supported by Windows can be displayed on the panel. The user can use up to 4 languages within a project, which makes it possible for global users to share their wisdom with their clients worldwide.

Completely support contrast and brightness adjustment

The contrast and brightness of the LCD can be adjusted online through setting special register without the need to adjust them by means of jumper switch or potentiometer.

Rich components library resources Facilitate in making beautiful configuration interfaces

The original components libraries of the HMIware can meet design requirements in most cases. If a customer has special requirement, he can build own graph library with the drawing tools of HMIware software. HMIware has a huge number of 3D effect components which facilitate in making mobile 3D graphics and animation.

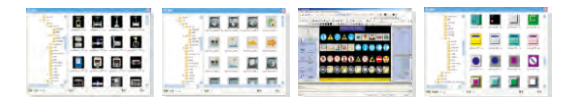

Bitmap image

Vector graph

Digital photos/Corporate logo import

The HMIware supports the import of multiple Windows image formats, such as JPEG, GIF and BMP. The user can import their own logo or other images as initial screen.

Supporting all fonts of the Windows platform

In graphic mode, static text can be displayed in any fonts supported by the windows system on the configuration interface. The user has more choice for fonts now.

Recipe editing function

Providing Max.256K Words recipe memory, without any loss upon power failure, facilitating the setting and modification of initial values of the equipment, capable of providing multiple different recipes for the controller.

Perfect event log function

It can store records of events occurred during production, without any loss upon power failure, facilitating invocation anytime; if necessary, this function can be used to learn the operational history of the equipment and improve the design of the process flow.

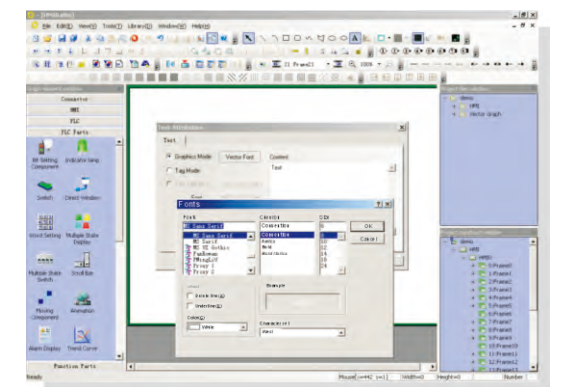



Learn compiling macro commands in ten minutes

Macro codes compatible with standard C language can be triggered in multiple methods, featuring powerful function and flexible use.

In the past

Most HMIs in the market use respectively defined script languages, lack of versatility, which are hard to learn since there is no sufficient reference resources, and furthermore they cannot be implanted into other HMI panels.

Present

The HMIware provides unique macro instruction compilation fully compatible with the standard C language. If you are familiar with the C language, you can learn how to code macro instructions in ten minutes. The rich reference documents, powerful function, and easy portability greatly enhance the macro command function of the HMIware.

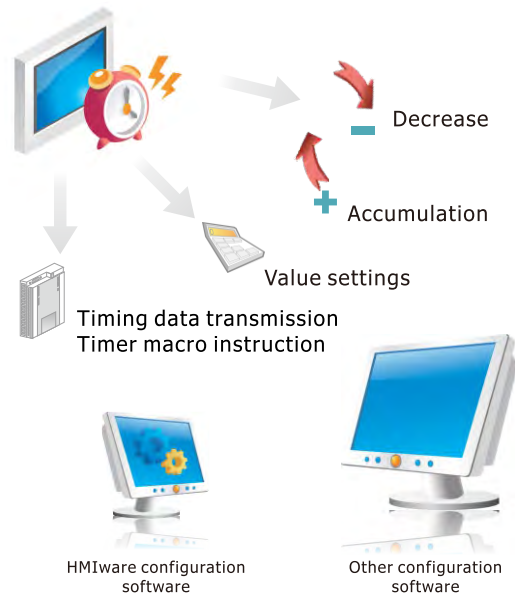
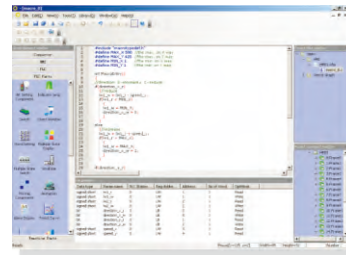

Powerful online networking and synchronous communication function and rapid processing speed have simplified the complicated process flow design.

Powerful timer function

- The timer of MT4000/MT5000 can implement the timing of a minimum of 100 ms, featuring accurate timing;
- Configured with multiple functions such as timed data transfer, value settings, accumulation, decrease, and timed macro instruction;
- Multiple trigger modes such as register trigger and initialization trigger, to facilitate users in implementing flexible configuration programming.

Customizable startup LOGO window

Different from other HMIs which do not have any screen display upon startup, the MT4000/MT5000 can immediately display a user-defined LOGO upon power-on until the configuration window finishes startup, lasting about five seconds. The user can freely edit and modify the startup window.

Provide Chinese Automation Solutions for Global Customers



Kinco provide total CANopen solution in Corrugated paper slitting machine

System: Kinco MT5000 Series HMI+Kinco F1 PLC+Kinco FD Series Servo
Features: -High efficiency,high accuracy
 -Easy programming
 -Simple wiring,more stable.



Kinco provides servo system in Wood-Carving machine

System: Kinco CD Series Servo
Features: -High efficiency,high accuracy.



Kinco provides CANopen servo system in Plasma cutting machine

System: Kinco JD Series Servo
Features: -High efficiency,high accuracy
 -Simple wiring,more stable.